

Performance Evaluation of Series Hybrid and Pure Electric Vehicles Using Lead-Acid Batteries and Supercapacitors

William F. Infante

Adrin F. Khan

Nathaniel Joseph C. Libatique, *Member, IEEE*

Gregory L. Tangonan, *Senior, IEEE*

Ateneo de Manila University

Quezon City, Philippines

Sherdon Nino Y. Uy

Manila Observatory

Quezon City, Philippines

Abstract— The adoption of pure electric and hybrid electric vehicles for public transportation poses a number of issues. In this paper, we simulate the implications of series hybrid- and pure electric- vehicles employing Pb acid battery-supercapacitor combinations. Our simulations suggest that peak fuel consumption is lessened to 31.3 percent in series hybrid electric vehicles when lead-acid batteries are coupled with supercapacitors compared to a system using batteries alone. Voltage fluctuations are reduced from 52 V difference to 1 V difference as the short transients are off-loaded to the supercapacitors. By altering the values for battery capacity, vehicle weight, and capacitance, the simulation suggests optimal operation ranges for targeted designs. In parts of the simulation, we took Metro Manila Jeepney drive cycle data characterized by frequent stop-and-start conditions and compared these to regularized routes travelling the same distance: the regularized drive cycles resulted in less battery parameter fluctuation for both models and less fuel consumption for the SHEV model with a value of 30.2 percent. The regularized route drive cycle needed lower-valued supercapacitors from 1700 F to 1000 F to produce the same performance. In addition, new driving cycles were also generated in NetLogo based on traffic policy assumptions.

Keywords— *series hybrid electric vehicles; supercapacitors; lead-acid batteries; quasi-static simulation*

I. INTRODUCTION

As the number of hybrid electric vehicles and pure electric vehicles continue to rise in the international market [1], it becomes more important to examine their implications for their use as vehicles in public transport systems. A critical deciding factor would be the energy storage system: the monitoring, maintenance, and management of the batteries. Although much research is currently invested in fuel and hydrogen cells as well as alternative battery designs, the low cost lead acid battery may still have much value especially if coupled with other energy storage elements that make up for its deficiencies. The most common energy buffers used in automobiles for their relative low cost are lead-acid batteries. Yet the chemical properties of lead acids do not permit rapid charging or

discharging without rise in temperature [2] that reduces its performance and long term contributes to its degradation. We propose the use of lead acid-supercapacitor combinations to address this problem. Supercapacitors have higher rates of charge and discharge compared to conventional batteries, and can be stored totally discharged, making them suitable as, for example, first storage elements in a regenerative braking system.

While it may take some decades [3] for supercapacitors to approach lead acids in terms of energy densities, one can already explore lead acid-supercapacitor combinations: in this work we simulate the performance of vehicles with combined energy buffers supercapacitors with lead acids – the supercapacitors act as energy buffers to accommodate fast peak power changes while the lead-acid components provide continuous power. Fig. 1 encapsulates the idea of using supercapacitors with lead-acid batteries for electric vehicle applications.

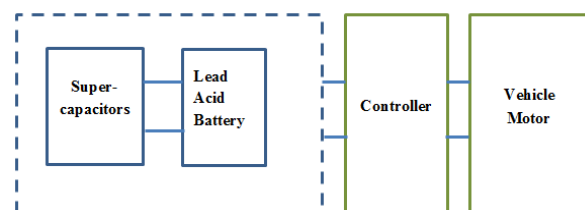

Figure 1. Supercapacitor-Lead Acid as energy buffers for vehicle models.

In congested urban areas, drive cycles are characterized by frequent stop-and-start traffic conditions. Fig. 2 shows the Jeepney driving cycle [4] [5] where Uy et. al. developed a hybrid vehicle model designed to evaluate vehicle performance under frequent stop-and-start conditions such as the ubiquitous public transport Jeepneys in Metro Manila. Policies such as the use of special lanes and designated stops for mass transportations are aimed at traffic decongestion and reducing

travel time. Examples are special taxi and bus lanes in Malaysia and the bus rapid transit systems in several countries such as United States, Canada and Australia [6].

In this paper, we will also explore how modifying the drive cycle via introduction of regular stop intervals affects the vehicle operation.

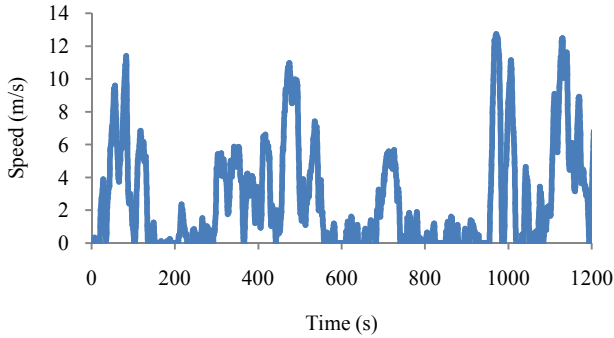

Figure 2. Jeepney Driving Cycle from UP National Center of Transportation Studies [7].

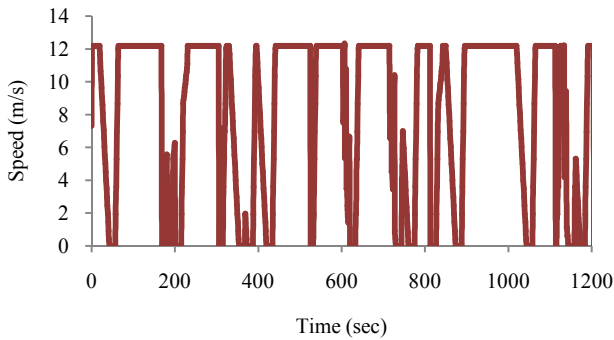

Figure 3. Typical Jeepney driving cycle generated from the NetLogo multi-agent three-lane traffic simulation

II. METHODOLOGY

We studied lead-acid batteries with supercapacitors as energy buffers using the quasi-static toolbox in MATLAB and Simulink. The use of the quasi-static simulation toolbox modeling for electric vehicle design and technological assessment is ideally suited for the optimization of fuel consumption in different control strategies [4].

We made different scenarios for both pure electric vehicles and series hybrid vehicles to explore the effect on battery parameters and fuel consumption by using supercapacitors with lead-acid batteries, by changing the parameters like capacitance value and battery charge capacity for optimal operation points, and by changing the Jeepney driving cycle into a regular route cycle. Aside from empirical data, we also generated drive cycles based on the NetLogo multi-agent simulation in three-lane traffic with a mixture of public transport Jeepneys and private cars. Both empirical and generated drive cycles can be used in the quasi-static analysis. Fig. 3 represents a typical Jeepney driving cycle from the NetLogo simulation in three-lane traffic. The summary of the simulation scenarios are listed in Table 1. In the simulations,

we used various drive cycles based on urban stop and go traffic in Metro Manila in addition to the assumed regularized route plans. When comparing model output, we assumed constant distances in the drive cycles across the various scenarios.

In the pure electric vehicle model, we assumed a vehicle designed to have a weight of 970 kg, a lead-acid battery module with 80 Ah battery capacities, and 27.78 percent initial charge. The supercapacitor block is 800 F and was placed in the model as seen in Fig. 4 for the electric vehicle module.

In the series hybrid vehicle with supercapacitors installed as in Fig. 5, the Jeepney driving cycle is repeated in the simulation to observe the change in the fuel consumption. The weight of the series hybrid electric vehicle is 1025 kg with a battery capacity of 80 Ah and 27.78 percent initial charge. The series hybrid model was designed such that fuel consumption occurs when the battery charge is low since that is when the combustion engine runs to recharge them.

In the parameter space, varying values of capacitance from 800 F to 1000 F were observed while holding the other vehicle parameters constant. The same method was applied when we changed the lead-acid battery capacity from 20 Ah to 100 Ah. However, in this case, a change of 0.76923Ah/kg in battery weight is taken into account. The initial charge of the battery is also 27.78%.

TABLE I. SUMMARY OF SIMULATIONS

Number	Simulation	Scenario	Driving Cycle
1	Battery Capacity	A, B, C, D	Jeepney Driving Cycle
2	Fuel Consumption	C, D	Repeated Jeepney Driving Cycle
3	Parameter Space	D	Repeated Jeepney Driving Cycle
4	Regular Route	B, D	Regular Route; Jeepney Driving Cycle; Repeated Jeepney Driving Cycle

Scenario A: Pure Electric Vehicle without supercapacitors
 Scenario B: Pure Electric Vehicle with supercapacitor block
 Scenario C: Series Hybrid Electric Vehicle without supercapacitors
 Scenario D: Series Hybrid Electric Vehicle with supercapacitor block

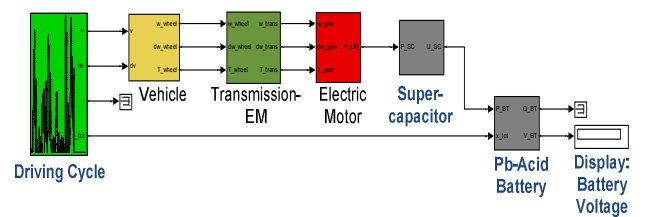

Figure 4. Pure electric vehicle with supercapacitor module.

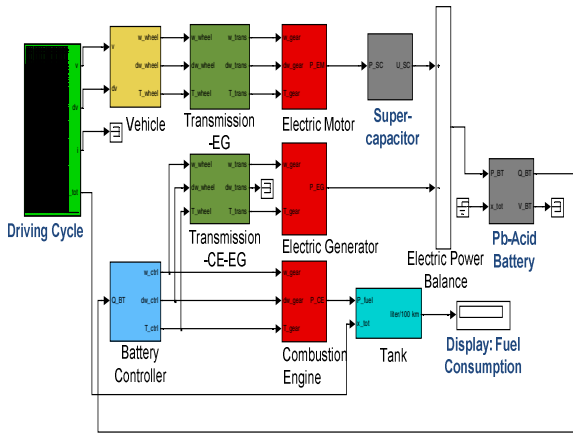

Figure 5. Series Hybrid Electric Vehicle with supercapacitor module.

III. RESULTS AND DISCUSSIONS

A. Effect of Using Supercapacitors

In the electric vehicle with supercapacitors, the battery charge ratio has smoother and less fluctuations compared to the electric vehicle model without supercapacitors. The range for the battery charge ratio without the supercapacitor is between 0.250 and 0.280 while the module with the supercapacitor is between 0.272 and 0.278.

There is also evident reduction in the voltage fluctuations as observed in the lead-acid battery parameters with the supercapacitor module installed. Instead of voltage values changing between 90 V to 140 V, the new model has little fluctuations within 1V range. The graph of the battery ratio as well as other battery parameters such as the current, voltage, and power are shown in Fig. 6 for the vehicle without supercapacitors and Fig. 7 for the vehicle with supercapacitors.

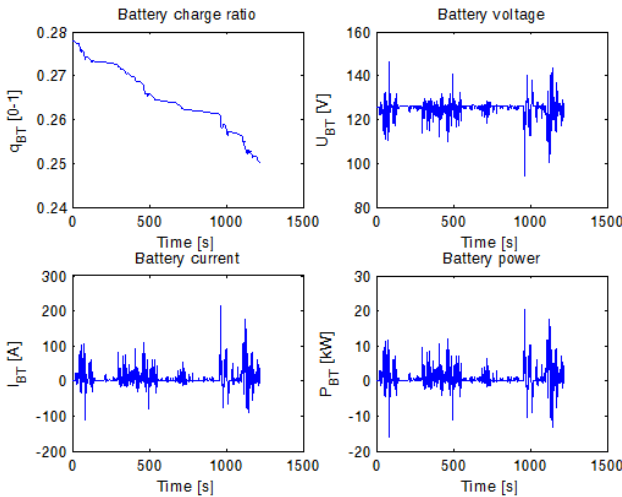

Figure 6. Battery Performance without the supercapacitor module in a pure electric vehicle model.

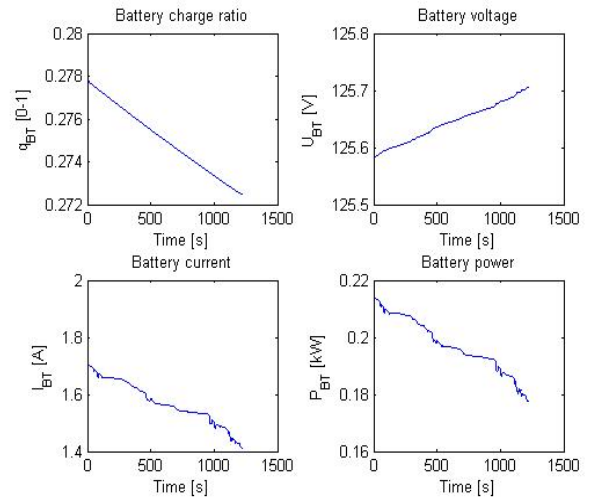

Figure 7. Battery Performance with the supercapacitor module in a pure electric vehicle model.

Sudden change in power demand is accommodated by the supercapacitors. The short transients are seen in the graphs from the supercapacitor given the Jeepney driving cycle in Fig. 8.

It is impractical in terms of economics and vehicle ergonomics to meet the power capacity higher than the average demand with using lead batteries alone just to accommodate the momentary peaks in the propulsion. The excess battery capacity will be unused most of the time, and the added load contributes to the fuel consumption. Adding supercapacitors in the electric vehicle model have shown the reduced voltage fluctuations.

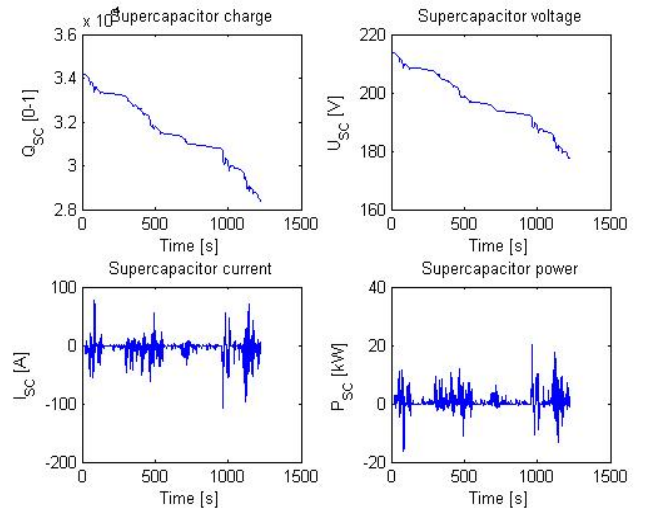

Figure 8. Supercapacitor performance in the pure electric vehicle given the Jeepney driving cycle.

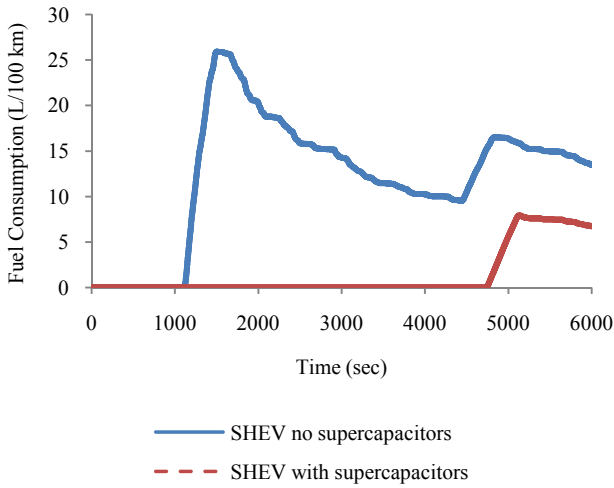

Figure 9. SHEV Fuel Consumption with and without Supercapacitors.

In the series hybrid vehicle model, the fuel consumption with supercapacitors started to consume at a later time and the maximum fuel consumption is at 8.1 liters/100 km. On the other hand, the series hybrid vehicle without the supercapacitors had maximum fuel consumption at 25.9 liters/100 km. Both simulations have the same drive cycles, and the model with supercapacitor reduced maximum fuel consumption to 31.3% of the one without it. The simulation without the supercapacitor also needed to recharge the battery more often as seen in the second rise in slope for the same drive cycle. Fig. 9 represent the series hybrid electric vehicle fuel consumption with and without the supercapacitor module respectively.

B. Parameter Space

We explored the parameter space vehicle weight, battery capacity, and capacitance value to find optimal operation points. The designer can choose what is suited for the application given a range of values. For example in the capacitance value, the higher the capacitance value chosen, the smaller is the voltage fluctuations but this might not be economical and may increase the overall weight of the vehicle.

A similar method was done in the battery capacity. That is, we change the values of the battery capacity and match the vehicle weight based on the change in battery weight while keeping the supercapacitance of 800 F constant. Fig. 10 represents the fuel consumption given different capacitance values and Fig. 11 represents fuel consumption given different battery capacities.

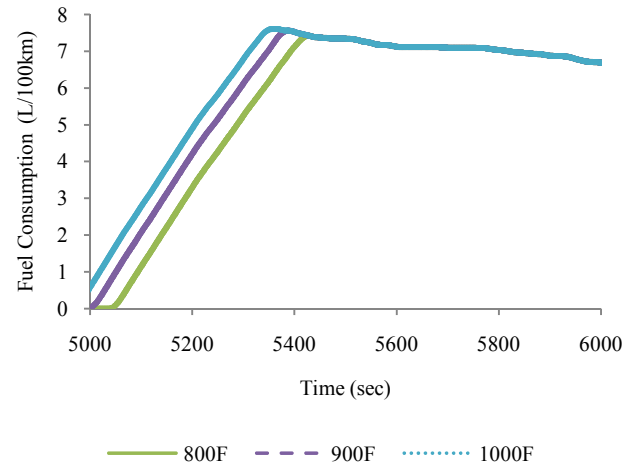

Figure 10. Fuel consumption of different capacitance values for the series hybrid electric vehicle model.

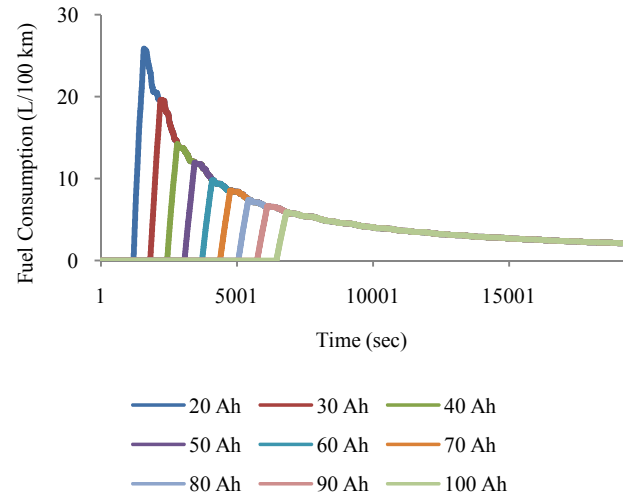

Figure 11. Fuel consumption with different battery capacity values for the series hybrid electric vehicle model.

C. Regular Route

All the previous analysis dealt with current urban traffic conditions such as that represented by typical drive cycles of public transportation Jeepneys in Metro Manila. In this section, we explore the effect of special lanes and strict enforcement of policies that require Jeepneys to stop only at specified places.

Fig. 12 represents the modified Jeepney driving cycle where it would move at constant velocity of 12.72 m/s for the ten minutes, and stop for 3 minutes. The slope between the constant velocity and stops is based on a Jeepney driving cycle section. The regular route driving cycle and repeated Jeepney driving cycle covered the same distance.

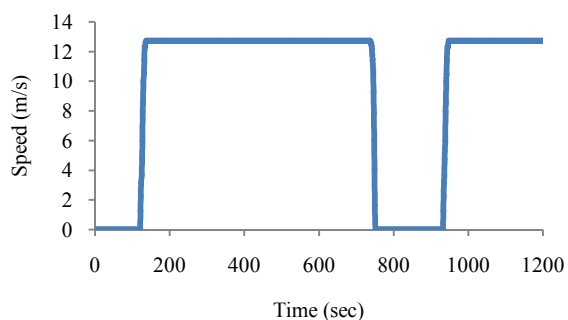

Figure 12. Regular route driving cycle based on the Jeepney driving cycle.

In the pure electric vehicle, the regular route driving cycle only needed 1000 F in comparison to the needed 1700 F in the repeated Jeepney driving cycle. There is also less voltage fluctuation in the battery performance of the regular route as compared to the Jeepney driving cycle.

In the series hybrid model travelling the regular route driving cycle consumed less fuel as compared the extended Jeepney driving cycle. The graphs of their fuel consumption are seen in Fig. 13. The characteristic of reducing the frequent stop-and-start conditions to regular routes produced savings in fuel consumption from the peak fuel consumption of 7.92 L/100km to 2.39 L/100km.

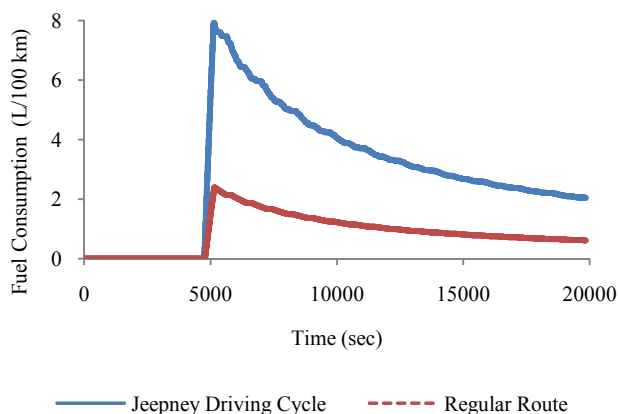

Figure 13. Comparison of the fuel consumption of a regular route driving cycle and Jeepney driving cycle.

IV. CONCLUSION

While much work needs to be done experimentally and theoretically, this work indicates that battery lifetime limitations affected by sharp transients of the lead-acid battery based electric vehicles may be overcome with the introduction of supercapacitors. The simulations also indicate that the use of lead-acid batteries in conjunction with supercapacitors compared to just using lead-acid batteries help in the reduction of fuel consumption in series hybrid vehicles and improved battery voltage, charge, and current parameters for both pure electric vehicles and series hybrid electric vehicles.

Simulations also suggests that having driving cycles with less stop-and-start conditions like those found in special lanes with designated stops improves fuel consumption in series hybrid vehicles.

ACKNOWLEDGMENT

We would like to thank the Department of Science and Technology through the Engineering Research for Development and Technology Program for supporting this work.

REFERENCES

- [1] J. Platt, "Electric vehicles on the rise: what does that mean for the engineering community?" *IEEE USA Today*. <http://www.todaysengineer.org/2010/Aug/electric-vehicles.asp>, Oct. 8, 2010.
- [2] L. Rosario, "Power and Energy Management of Multiple Energy Storage Systems in Electric Vehicles," Ph.D. dissertation, Dept. Aerospace Power and Sensors, Cranfield Univ., Wiltshire, UK, 2007.
- [3] Ball, R, "Supercapacitors see growth as costs fall." *Electronics Weekly* <http://www.electronicsweekly.com/Articles/2006/03/03/37810/Supercapacitors-see-growth-as-costs-fall.htm>, Mar. 3, 2006
- [4] N. Uy, "Hybrid Electric Vehicle Simulation and Prototype Development for Stop and Go Traffic Conditions," M.S. thesis, Dept. Physics, Ateneo de Manila Univ., Philippines, 2010.
- [5] L. Guzella, A. Amstutz, *The QSS Toolbox Manual*, Zurich, Switzerland: Institut für Mess- und Regeltechnik, 2005
- [6] C. Thole, *Bus Rapid Transport System*, Florida: National BRT Institute, Center for Urban Transportation Research, University of South Florida, 2011.
- [7] E. Abaya, K. Vergel, R. Sigua, *Development of drive cycles, emission, and fuel consumption factors of light duty vehicles in Metro Manila*, Manila, Philippines: 3rd ERDT Conference Proceedings, p. 70-73, 2009.